

SK0946A OPEN FRAME SOLENOID

UNIT : mm
SHOWN ENERGIZED

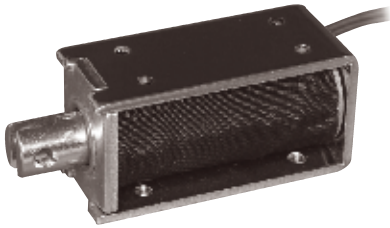

WEIGHT : 96g
PLUNGER: 20g

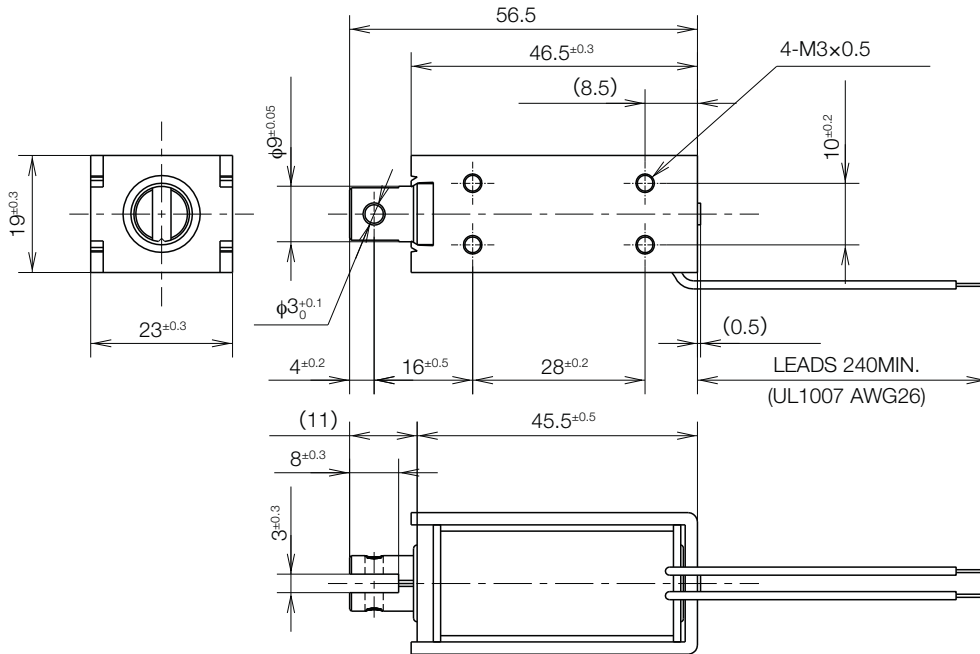
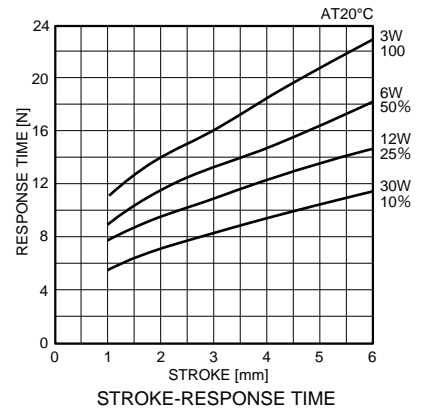
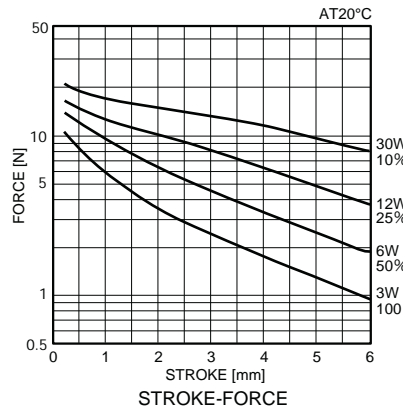

FRAME THK. 1.6mm POSSIBLE EXTRUSION: LESS THAN 0.8mm

COIL DATA

	without heat sink					
	duty cycle= $\frac{\text{"on" time}}{\text{"on" time} + \text{"off" time}} \times 100\%$	100% continuous	50% or less	25% or less	10% or less	
	MAX. "on" time in seconds	∞	100	36	7	
	watts at 20°C	3.0	6.0	12.0	30.0	
ampere-turns at 20°C	585	827	1170	1849		
type no.	resistance Ω±10%(at 20°C)	no. turns	volts DC			
SK0946A06AA	12	1120	6	8.5	12	19
SK0946A12AA	48	2320	12	17	24	38
SK0946A24AA	192	4680	24	34	48	76
SK0946A48AA	768	9000	48	68	96	152